

Siltala Yachts



NAUTICAT 385

ELECTRICAL SYSTEM

Hull no: 4

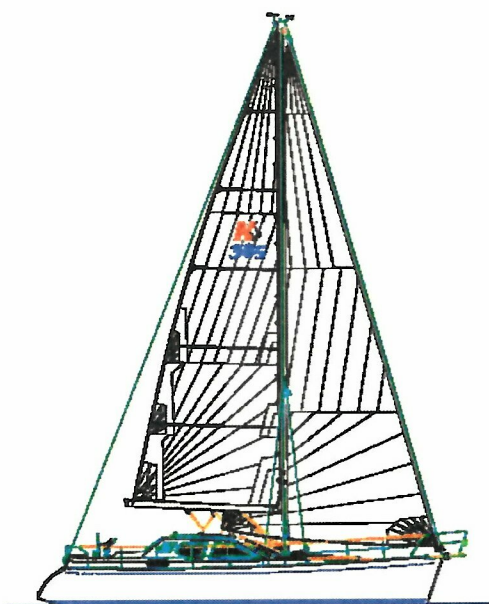

Installed by



P.O.Box 25 FIN-20201 Turku

FINLAND

Phone: +358 2 5100300

Fax: +358 2 5100340

03.01.06

www.lst.fi

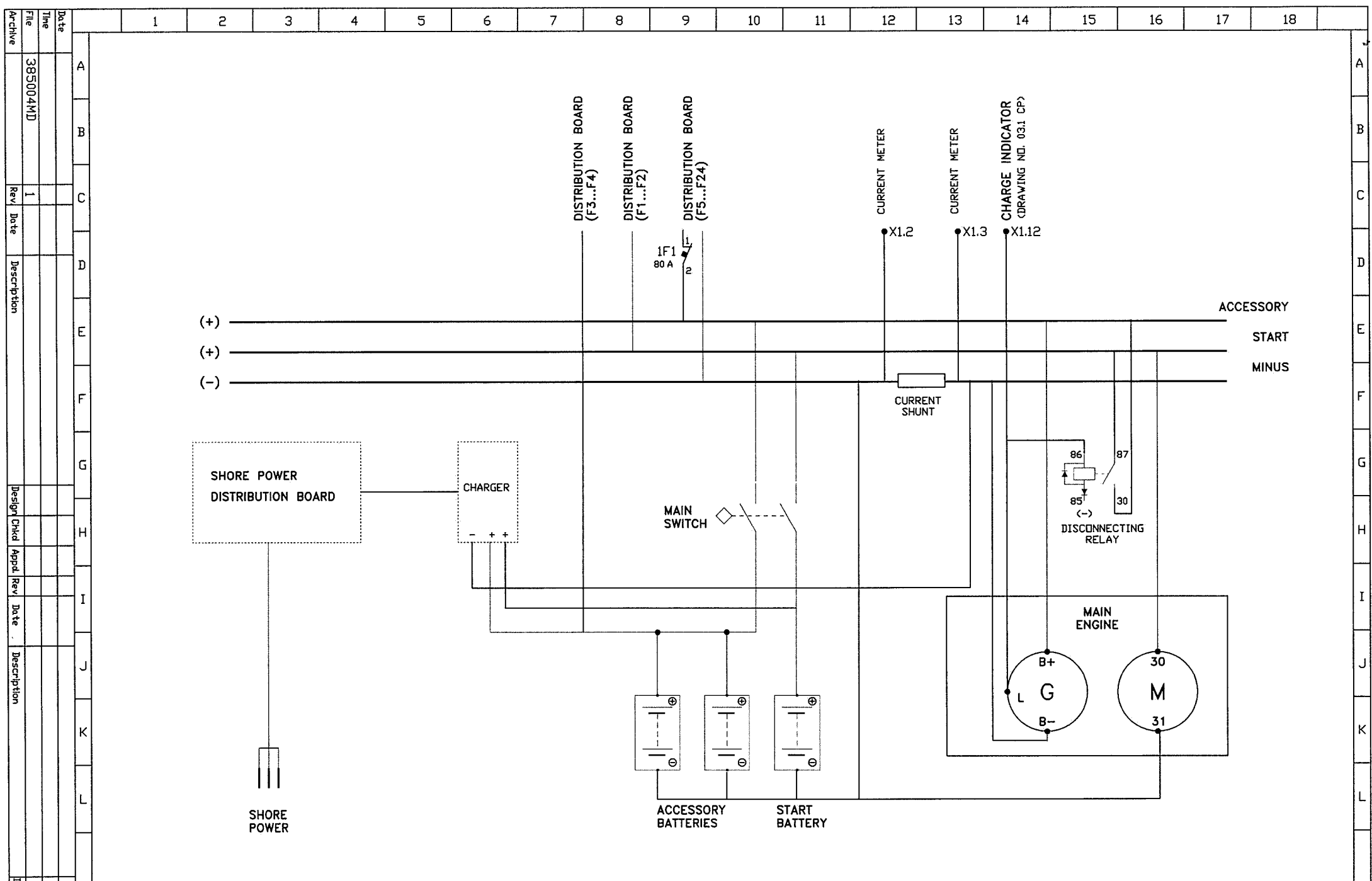

Archiv	
File	385004MD
Time	
Date	
Rev.	1
Date	
Description	
Design Chkd	
Appd.	
Rev.	
Date	
Description	
Design Chkd	
Appd.	

LAIVASÄHKÖTYÖ OY
 P.O.Box 25, 20201 Turku, Finland
 Phone: +358 (0)2 5100 300
 Fax: +358 (0)2 5100 340

Appd.	
Chkd	
Design	JSH
Date	03012006

Title
 SILTALA YACHTS
 NAUTICAT
 MAIN DIAGRAM
 385/004

Drawing No	01.1	
Sheet	1	Cont.
Rev.		
Drawing No	01.1MD	

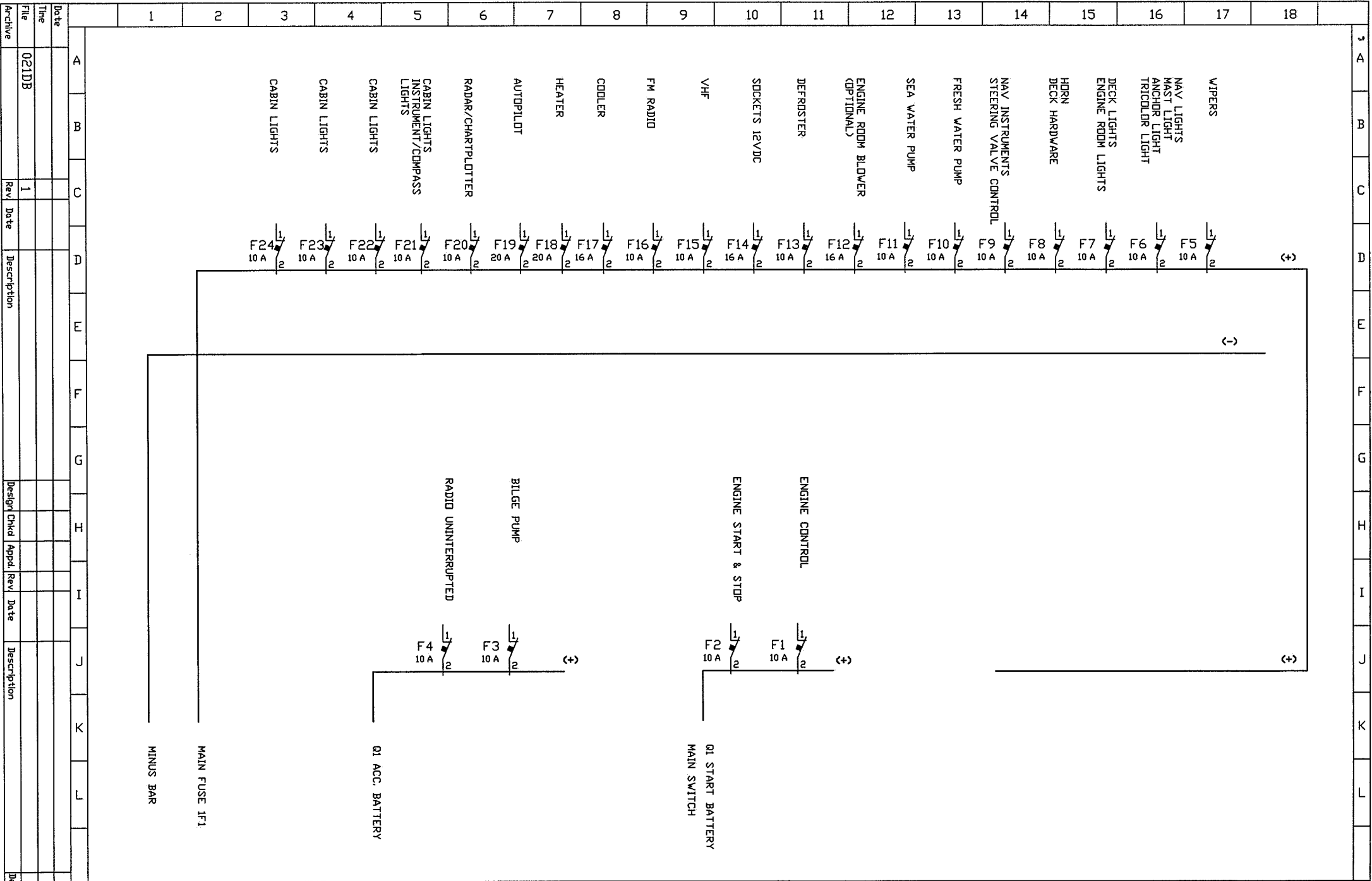

Archive	File	Date	Rev.	Date	Description	Design	Chkd	Appd.	Rev.	Date	Description
	021DB		1								

LAIVASÄHKÖTYÖ OY
 P.O.Box 25, 20201 Turku, Finland
 Phone: +358 (0)2 5100 300
 Fax: +358 (0)2 5100 340

Appd.	
Chkd	
Design	JSH
Date	21062005

Title
 SILTALA YACHTS
 NAUTICAT
 DISTRIBUTION BOARD

Drawing No	02.1	
Sheet	1	Cont.
Rev.		
Drawing No	02.1 DB	

File	031CPE	Rev	1
Time		Date	

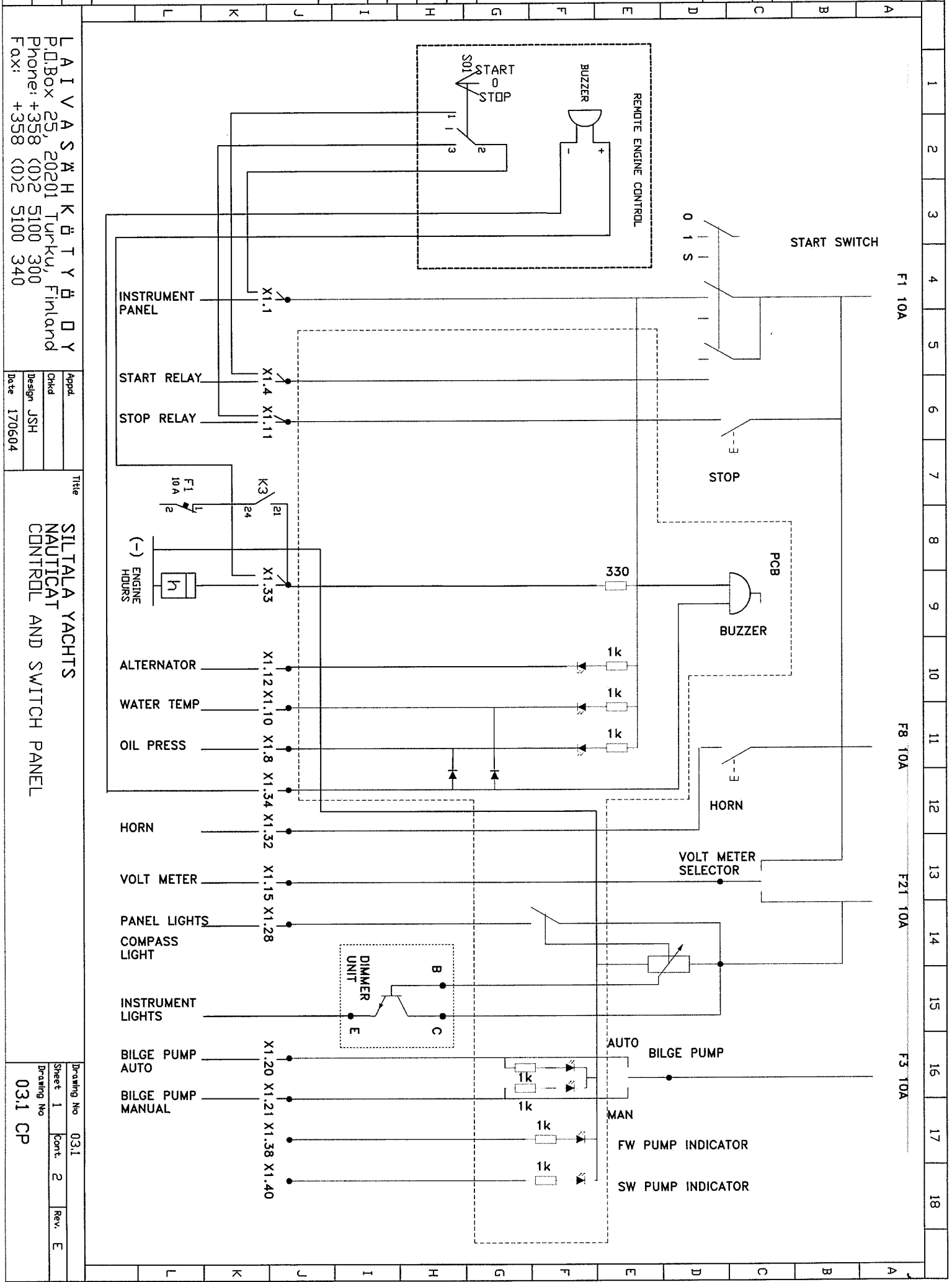

LAIVASSAHKÖITYÖ
 P.O.Box 25, 20201 Turku, Finland
 Phone: +358 (0)2 5100 300
 Fax: +358 (0)2 5100 340

Appd	CHKd
Design	JSH
Date	170604

Title
 SILTALA YACHTS
 NAUTICAL
 CONTROL AND SWITCH PANEL

Drawing No	031
Sheet	1
Cont.	2
Rev.	E
Drawing No	031 CP

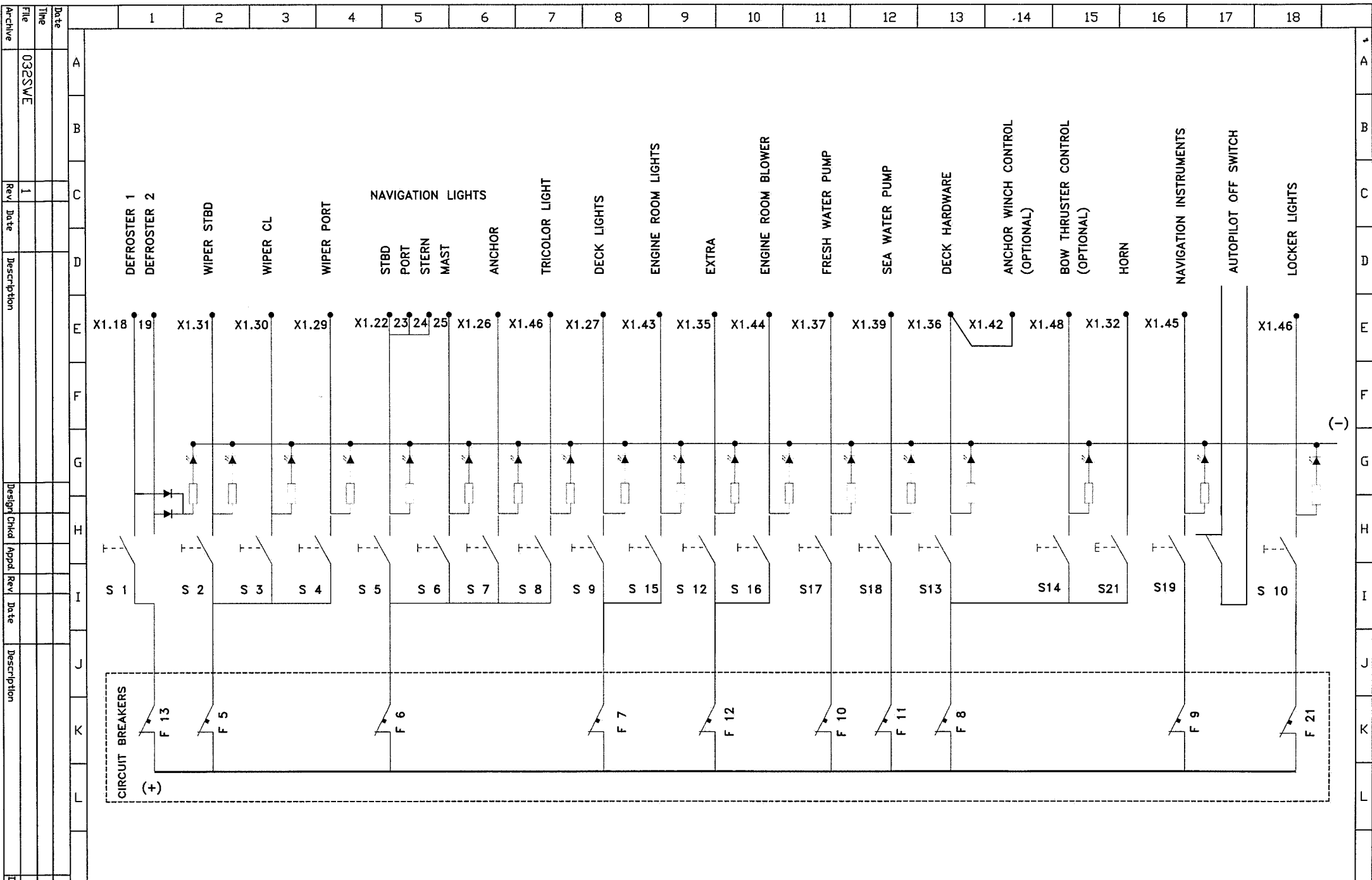

Archive	
File	032SWE
Rev	1
Date	
Description	
Design Chkd	
Appd	
Rev	
Date	
Description	
Design Chkd	
Appd	

L A I V A S Ä H K Ö T Y Ö O Y
P.O.Box 25, 20201 Turku, Finland
Phone: +358 (0)2 5100 300
Fax: +358 (0)2 5100 340

Appd.	
Chkd	
Design	JSH
Date	24112004

Title
SILTALA YACHTS
NAUTICAT
CONTROL AND SWITCH PANEL

Drawing No	03.2	
Sheet	2	Cont. 2
Rev.		
Drawing No	03.2 CP	

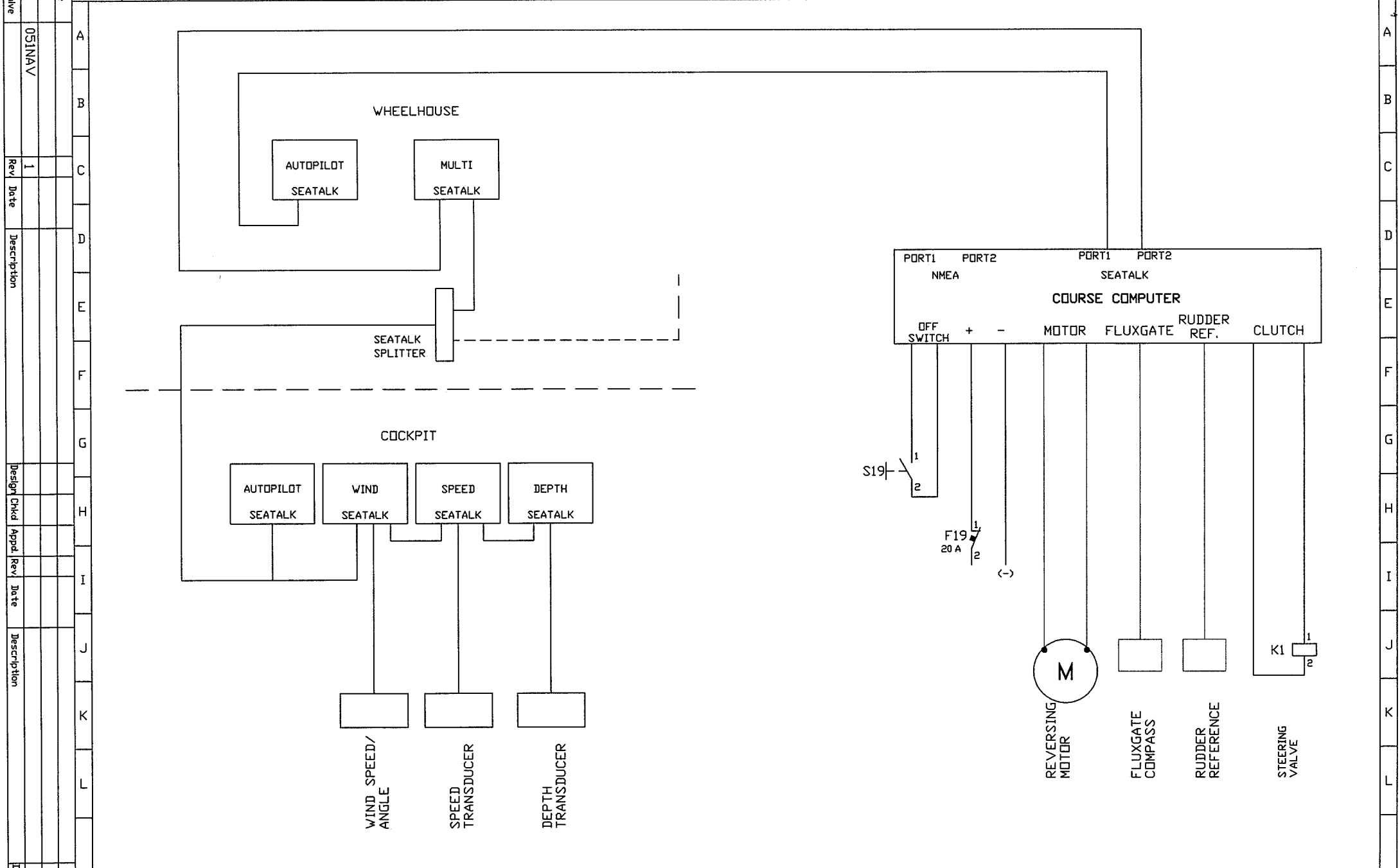

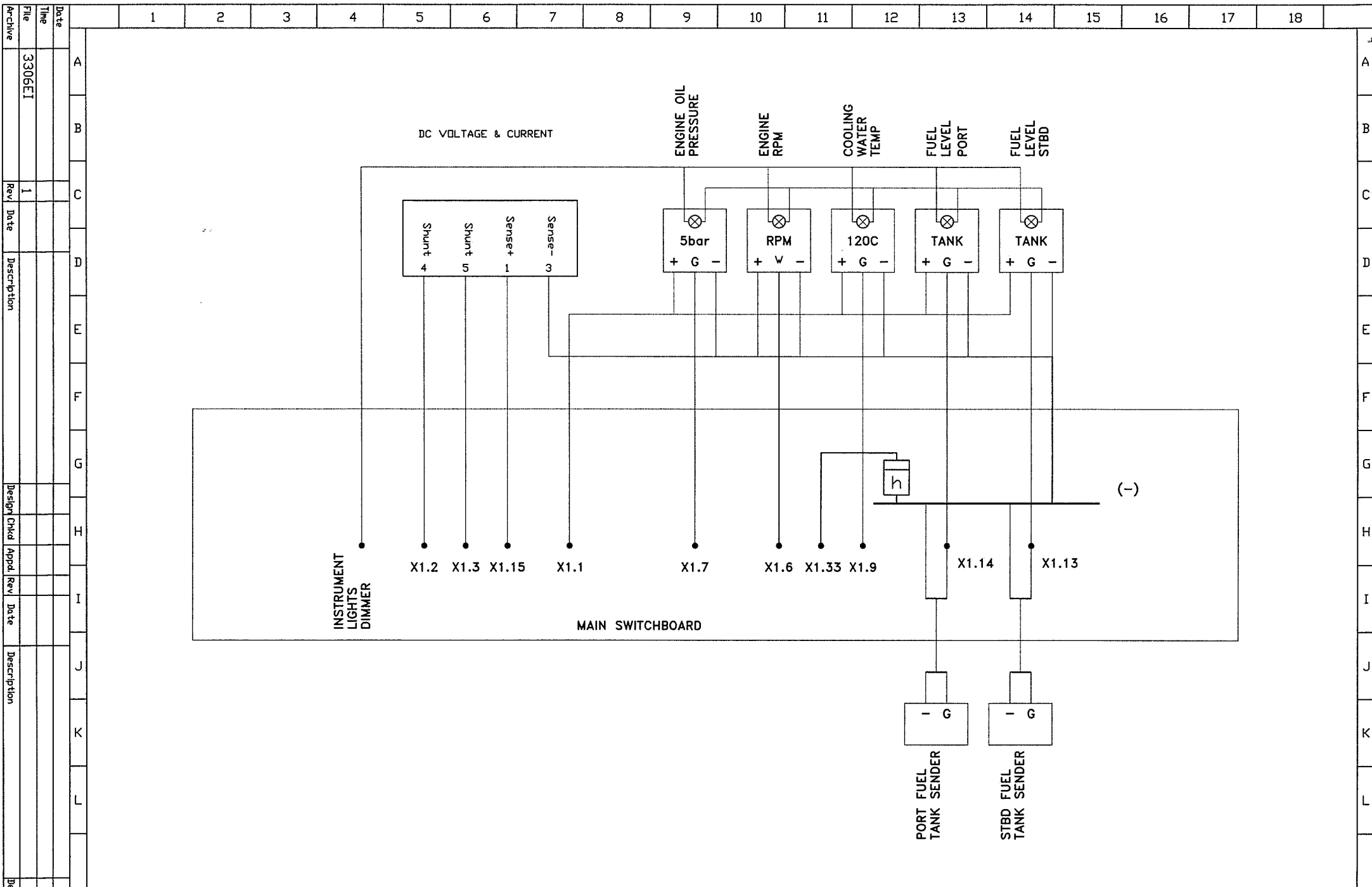

Archive	File	Date
	3306EI	
Rev	1	
Date		
Description		
Design Chkd	Appd	Rev
Date		
Description		
Design Chkd	Appd	

L A I V A S Ä H K Ö T Y Ö O Y
P.O.Box 25, 20201 Turku, Finland
Phone: +358 (0)2 5100 300
Fax: +358 (0)2 5100 340

Appd.	
Chkd	
Design	JSH
Date	29062005

Title
SILTALA YACHTS
NAUTICAT
ENGINE INSTRUMENTS

Drawing No	33.06	
Sheet	1	Cont.
Rev.		
Drawing No	33.06 EI	

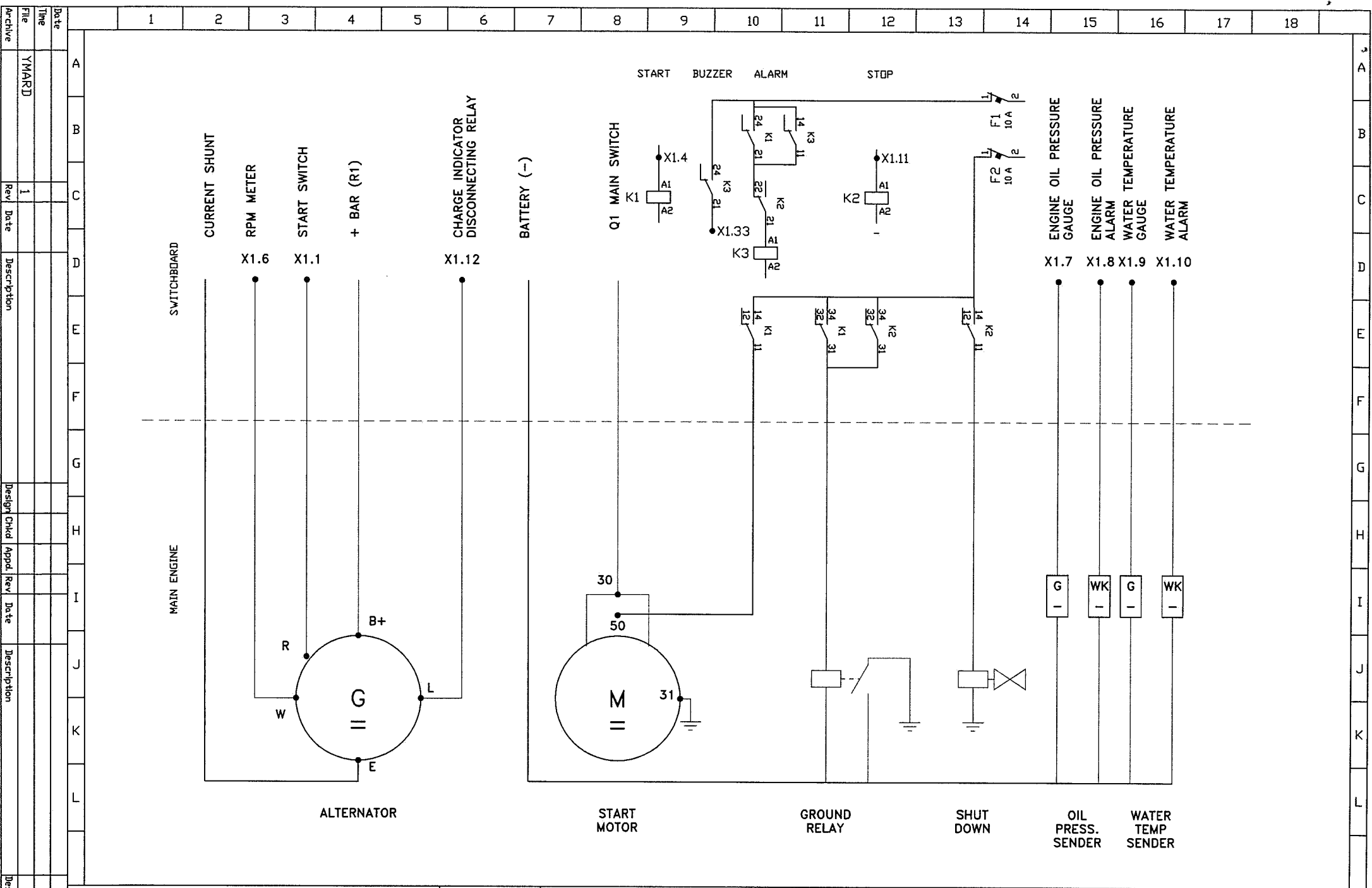

LAIVASÄHKÖTYÖ OY
 P.O.Box 25, 20201 Turku, Finland
 Phone: +358 (0)2 5100 300
 Fax: +358 (0)2 5100 340

Appd. _____
 Chkd _____
 Design JSH
 Date 17092004

Title
 SILTALA YACHTS
 NAUTICAT
 MAIN ENGINE
 YANMAR

Drawing No
 Sheet 1 Cont. Rev. D
 Drawing No
 100012.07C

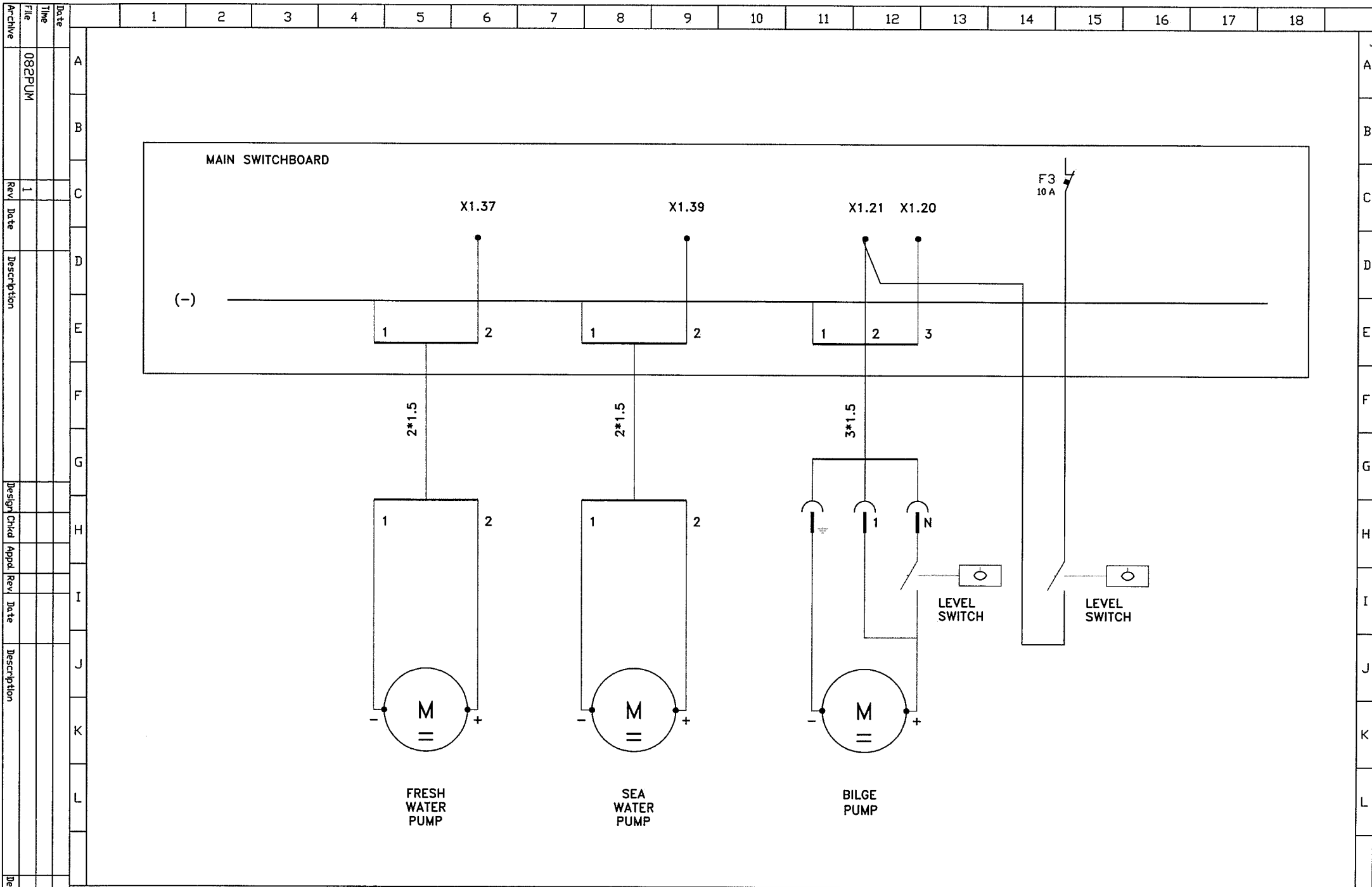

L A I V A S Ä H K Ö T Y Ö O Y
P.O.Box 25, 20201 Turku, Finland
Phone: +358 (0)2 5100 300
Fax: +358 (0)2 5100 340

Appd.
Chkd
Design JSH
Date 25012005

Title
SILTALA YACHTS
NAUTICAT
PUMPS AND BLOWERS

Drawing No 08.2	
Sheet 1	Cont.
Drawing No 08.2 PUM	

1 2 3 4 5 6 7 8 9 10 11 12 13 14 15 16 17 18

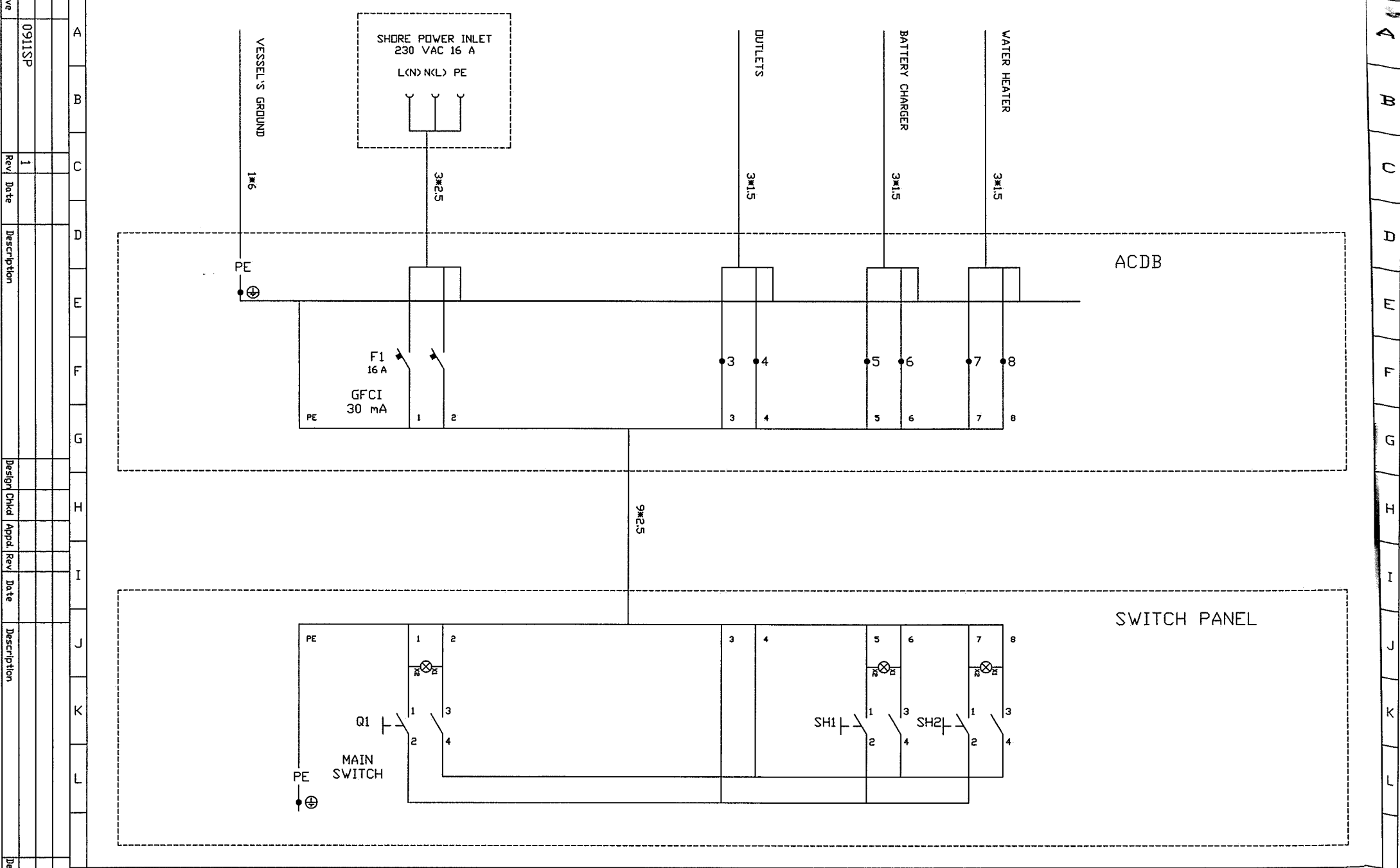

File	0911SP
Rev	1
Description	
Design Chkd	
Appd	
Rev	
Date	
Description	
Design Chkd	
Appd	
Rev	
Date	

L A I V A S Ä H K Ö T Y Ö O Y
 P.O.Box 25, 20201 Turku, Finland
 Phone: +358 (0)2 5100 300
 Fax: +358 (0)2 5100 340

Appd.	
Chkd	
Design	JSH
Date	25052004

Title
 SILTALA YACHTS
 NAUTICAT
 ALTERNATING CURRENT SYSTEM

Drawing No	09.1.1 SP	
Sheet	1	Cont.
Rev.		
Drawing No	09.1.1 SP	

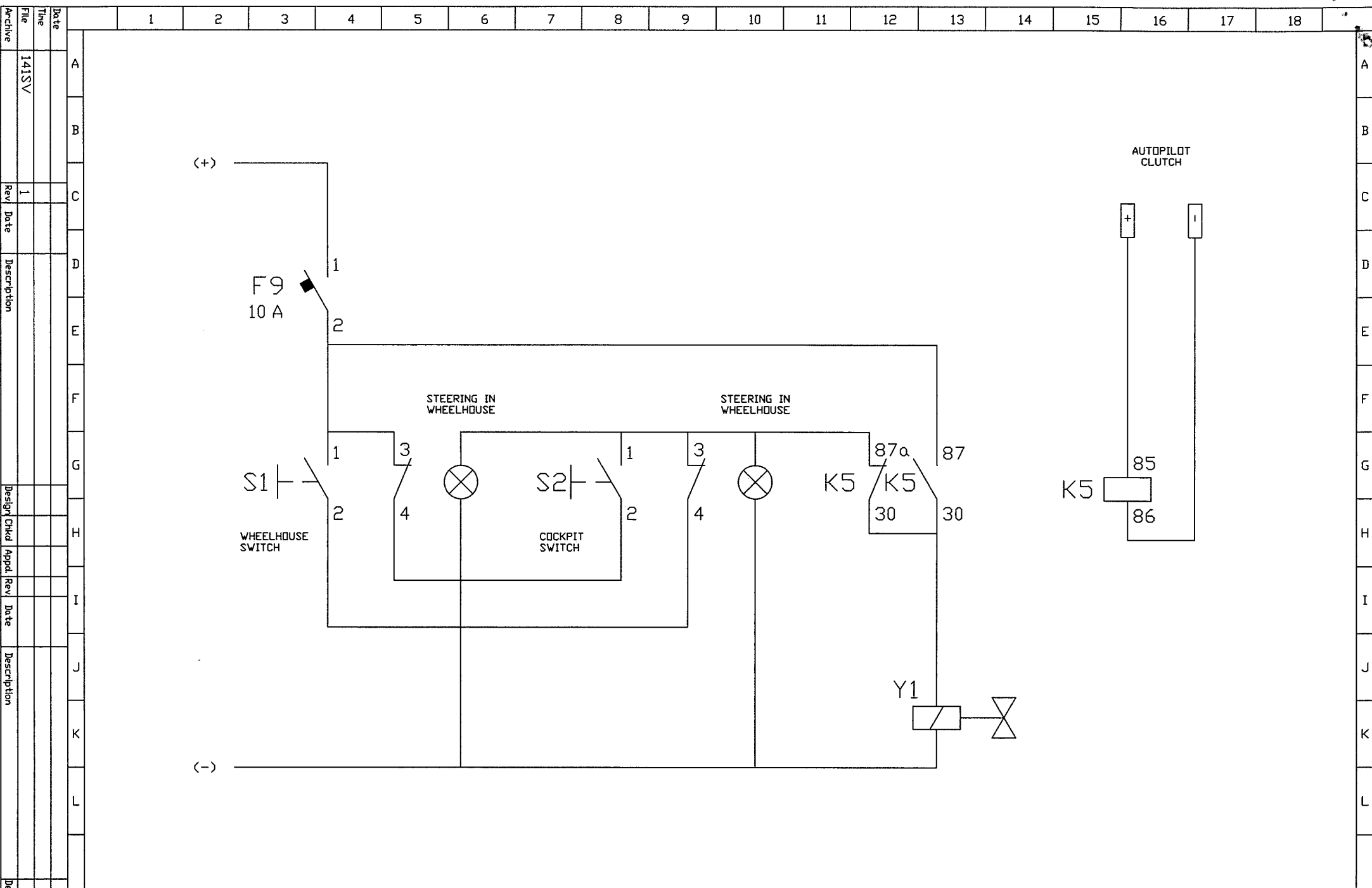

Date	
File	141SV
Rev	1
Date	
Description	
Design Chkd	
Appd	
Rev	
Date	
Description	
Design Chkd	
Appd	

LAIVASÄHKÖTYÖ OY
P.O.Box 25, 20201 Turku, Finland
Phone: +358 (0)2 5100 300
Fax: +358 (0)2 5100 340

Appd.	
Chkd	
Design	JSH
Date	250504

Title
SILTALA YACHTS
NAUTICAT
STEERING VALVE

Drawing No 14.1SV		
Sheet 1	Cont.	Rev.
Drawing No 14.1SV		